



MAX1636 CPU Supply Evaluation Kit

Evaluates: MAX1636

General Description

The MAX1636 CPU supply evaluation kit (EV kit) circuit is intended for converting high-voltage battery power into a low-voltage supply rail for next-generation notebook CPU cores. The output is digitally adjustable between 1.25V and 2V, in 50mV increments. The input range is +7V to +22V. It delivers up to 7A output current with greater than 87% efficiency. The MAX1636 features $\pm 1\%$ DC output accuracy over all conditions of line, load, and temperature. The fully assembled and tested EV kit has excellent dynamic response to correct for fast load transients.

This EV kit is very specific to notebook CPU core power supplies, and includes a digital-to-analog converter (DAC), op-amp buffer, and other high-performance components tailored to this demanding application. However, the MAX1636 is a general-purpose, stand-alone device that can be used without the DAC; see the MAX1636 data sheet for standard application circuits.

Ordering Information

PART	TEMP. RANGE	IC PACKAGE
MAX1636CPUEVKIT	0°C to +70°C	20 SSOP

Features

- ◆ +7V to +22V Input Voltage Range
- ◆ Digitally Adjustable 1.25V to 2V Output Voltage
- ◆ 7A Output Current Capability
- ◆ $\pm 1\%$ DC Output Accuracy
- ◆ Efficiency = 87%, $V_{IN} = 7V$, $V_{OUT} = 1.7V$ (at $I_{OUT} = 3A$)
- ◆ Fast MOSFETs for Low Switching Losses
- ◆ Tight PC Board Layout for Low Switching Losses
- ◆ Power-Good Output
- ◆ 300kHz Switching Frequency
- ◆ Overvoltage and Undervoltage Protection
- ◆ Surface-Mount Construction
- ◆ Fully Assembled and Tested

Component List

DESIGNATION	QTY	DESCRIPTION
C1, C2, C3, C4	4	10 μ F, 25V ceramic capacitors Tokin C34Y5U1E106Z or United Chemicon/Marcon THCR50E1E106ZT
C5, C7, C8, C9, C10	5	0.1 μ F ceramic capacitors
C11	1	1500pF ceramic capacitor
C12	1	1 μ F ceramic capacitor
C13	1	4.7 μ F, 16V tantalum capacitor Sprague 595D475X0016A2B
C14, C15, C16	3	470 μ F, 6.3V, 30m Ω low-ESR tantalum capacitors Kemet T510X477M006
C14, C15, C16, C17	4	or 470 μ F, 4V, 55m Ω low-ESR tantalum caps Sprague 594D477X0004R2T
C18	0	Open
D1	1	Schottky diode SGS-Thomson STPS2L25U, International Rectifier 10BQ040, or Motorola MBRS130LT3
D2	1	Schottky diode Central Semiconductor CMPSH-3

DESIGNATION	QTY	DESCRIPTION
L1	1	2.2 μ H power inductor Panasonic P1F2R0HL, Coiltronics UP4-2R2, or Coilcraft DO5022P-222HC
N1	1	N-channel MOSFET Fairchild FDS9412, International Rectifier IRF7803, or Siliconix Si9804DY
N2	1	N-channel MOSFET Fairchild FDS6680, International Rectifier IRF7801, or Siliconix Si4420DY
R1	1	0.010 Ω , 1%, 1W resistor Dale WSL-2512-R010F
R2	1	10k Ω , 0.1% resistor Dale TNPW-1206 series
R3	1	110k Ω , 0.1% resistor Dale TNPW-1206 series
R4	1	13.7k Ω , 0.1% resistor Dale TNPW-1206 series
R5	1	51 Ω , 5% resistor
R6, R15	2	100k Ω , 5% resistors



MAX1636 CPU Supply Evaluation Kit

Component List (continued)

DESIGNATION	QTY	DESCRIPTION
R7	1	20Ω, 5% resistor
R8–R12, R14, R15, R16	8	1MΩ, 5% resistors
SW1	1	Four-position dip switch
U1	1	MAX1636EAP (20-pin SSOP)
U2	1	MAX5480BEEE (16-pin QSOP)
U3	1	MAX4332ESA (8-pin SO) or MAX4163ESA (alternate type with lower supply current but slightly degraded accuracy)
None	1	MAX1636 PC board
None	1	MAX1636 data sheet
JU3, JU4, JU5	3	2-pin header

Component Supplier

SUPPLIER	PHONE	FAX
AVX	(803) 946-0690	(803) 626-3123
Central Semiconductor	(516) 435-1110	(516) 435-1824
Coilcraft	(847) 639-6400	(847) 639-1469
Dale-Vishay	(402) 564-3131	(402) 563-6418
Fairchild	(408) 721-2181	(408) 721-1635
International Rectifier	(310) 322-3331	(310) 322-3332
IRC	(512) 992-7900	(512) 992-3377
Kemet	(864) 963-6300	(864) 963-6521
Motorola	(602) 303-5454	(602) 994-6430
Panasonic	(201) 348-7522	(201) 392-4441
Sanyo	(619) 661-6835	(619) 661-1055
SGS-Thomson	(617) 259-0300	(617) 259-9442
Siliconix	(408) 988-8000	(408) 970-3950
Sprague	(603) 224-1961	(603) 224-1430
Sumida	(847) 956-0666	(847) 956-0702
Token	(408) 432-8020	(408) 434-0375
Vishay/Vitramon	(203) 268-6261	(203) 452-5670

Note: Please indicate that you are using the MAX1636 when contacting these component suppliers.

Quick Start

The MAX1636 EV kit is fully assembled and tested. Follow these steps to verify board operation. **Do not turn on the power supply until all connections are completed.**

- 1) Connect a +7V to +22V supply voltage to the VIN pad. Connect ground to the GND pad.
- 2) Connect a voltmeter and load, if any, to the VOUT pad.
- 3) Turn on the power supply to the board. Verify that the output voltage is 2V (SW1 set to all zeros).
- 4) Set switch SW1 per Table 1 to get the desired output voltage. Input power may need to be cycled off and on for new voltage settings to take effect.

Table 1. Output Voltage Settings

D3	D2	D1	D0	V _{OUT} (V)
0	0	0	0	2.00
0	0	0	1	1.95
0	0	1	0	1.90
0	0	1	1	1.85
0	1	0	0	1.80
0	1	0	1	1.75
0	1	1	0	1.70
0	1	1	1	1.65
1	0	0	0	1.60
1	0	0	1	1.55
1	0	1	0	1.50
1	0	1	1	1.45
1	1	0	0	1.40
1	1	0	1	1.35
1	1	1	0	1.30
1	1	1	1	1.25

MAX1636 CPU Supply Evaluation Kit

Evaluates: MAX1636

Detailed Description

The MAX1636 EV kit provides a digitally adjustable output voltage between 1.25V and 2V from a +7V to +22V input supply. The output voltage is digitally adjusted by the MAX5480, a multiplying DAC, which sums a variable output current into the FB feedback node. This DAC operates in voltage-output mode and relies on the precise MAX1636 REF output to generate an accurate reference current. The DAC has buffer amplifiers on the input and output to prevent the R2R ladder in the MAX5480 from excessively loading the reference or interacting with the normal FB resistor-divider impedance. The buffered DAC output swings 0V to REF - 1LSB. Refer to Table 1 for the digital-to-analog (D/A) codes.

The MAX1636 IC is rated for 30V input; however, the EV kit is restricted to 22V operating range (25V absolute maximum) due to the ratings of external components and minimum duty-factor limitations.

Table 2. Jumper JU2 Functions

SHUNT LOCATION	MAX1636 SKIP PIN	OPERATING MODE
Off	Connected to GND	Idle mode, pulse-skipping operation for highest light-load efficiency
On	Connected to VCC	Low-noise mode, fixed-frequency PWM operation.

The 2-pin header JU3 selects the operating frequency. Table 3 lists the selectable jumper options. The EV kit's components are selected for 300kHz operation. Component values might need to be changed if 200kHz operation is selected (refer to the *Design Procedure* section in the MAX1636 data sheet). Synchronize the oscillator to an external clock signal by driving the SYNC pad with a 5V amplitude pulse train in the 240kHz to 350kHz frequency range.

Table 3. Jumper JU3 Functions

SHUNT LOCATION	MAX1636 SYNC PIN	FREQUENCY (kHz)
Off	Connected to VCC	300
On	Connected to GND	200

The 2-pin header JU4 selects the overvoltage protection. The 2-pin header JU5 selects the shutdown mode. Table 4 lists the selectable jumper options.

Table 4. Jumper JU4 and JU5 Selection

SHUNT LOCATIONS		OVP PIN TIED TO	SHDN PIN TIED TO	RESULT
JU4	JU5			
Off	Off	VCC	VIN	RUN mode, OVP enabled
Off	On	VCC	GND	Standby mode, VL output alive
On	Off	GND	VIN	RUN mode, OVP disabled
On	On	GND	GND	Total shutdown mode

Latched Fault Protection

The MAX1636 contains a latched fault-protection circuit that disables the IC when the output is overvoltage or undervoltage (or when thermal shutdown is triggered). Once disabled, the supply won't attempt to restart until input power is cycled or until SHDN (JU5) is cycled. A fault condition can be triggered by overloading the output, overvoluting the output (which can happen when changing the D/A code settings), or by touching sensitive compensation or feedback nodes.

Optional +5V Chip-Supply Input

An optional +5V supply input (Figure 1) can power the IC and gate drivers to improve efficiency. The idea is to power the IC from an efficient source (the +5V system supply, typically 95% efficient) instead of relying on the inefficient internal VL linear regulator. To test this feature, cut the trace at V+ and connect V+ to VL to disable the linear regulator, and connect an external +5V, 50mA supply to the optional input.

Alternate Op Amp for Lower Supply Current

The MAX4332 op amp provided with this kit is very accurate but draws up to 500µA supply current. For improved supply current draw with a slight (0.4%) degradation in output voltage accuracy, replace the MAX4332 with a MAX4163, which draws 25µA (typ).

MAX1636 CPU Supply Evaluation Kit

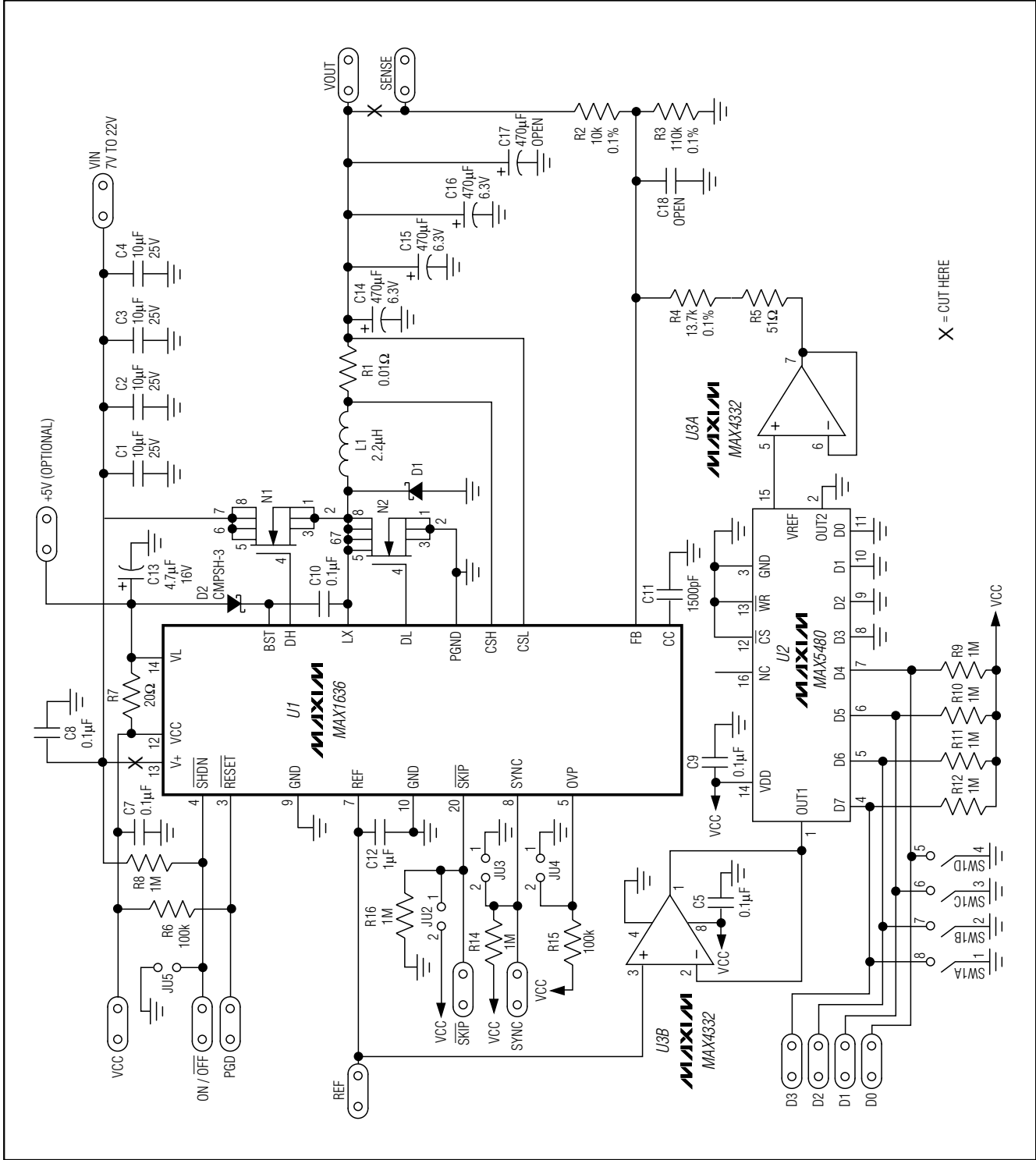

Figure 1. MAX1636 EV Kit Schematic

MAX1636 CPU Supply Evaluation Kit

Evaluates: MAX1636

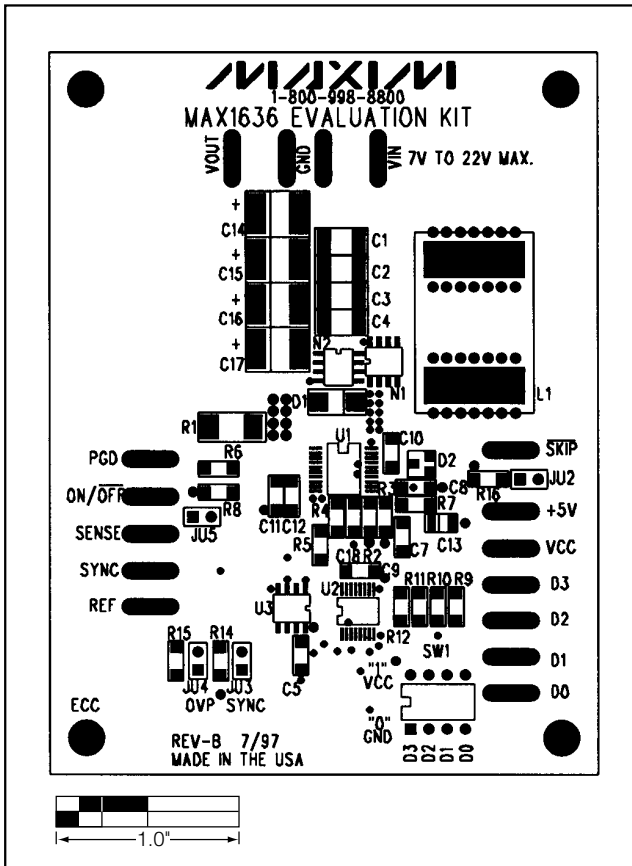

Figure 2. MAX1636 EV Kit Component Placement Guide—Component Side

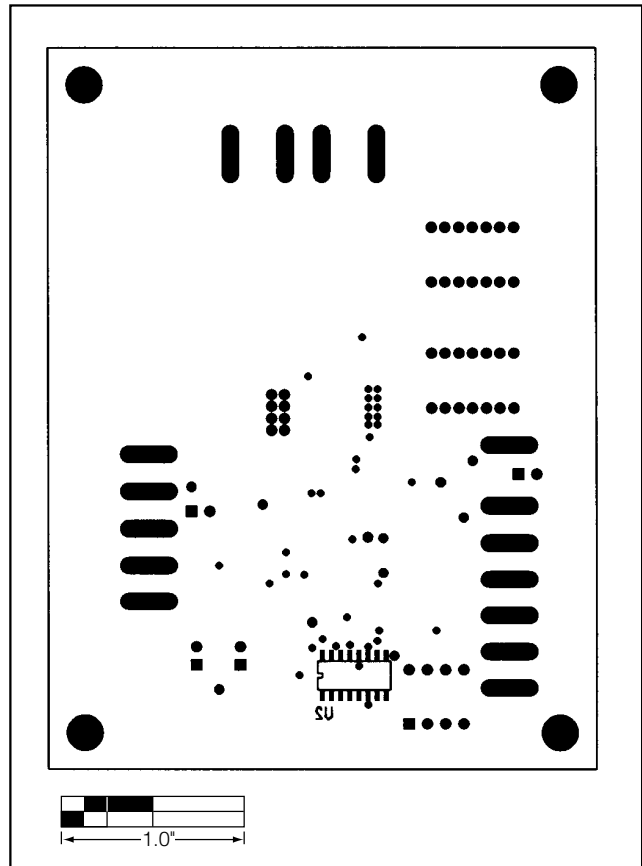

Figure 3. MAX1636 EV Kit Component Placement Guide—Solder Side

MAX1636 CPU Supply Evaluation Kit

Evaluates: MAX1636

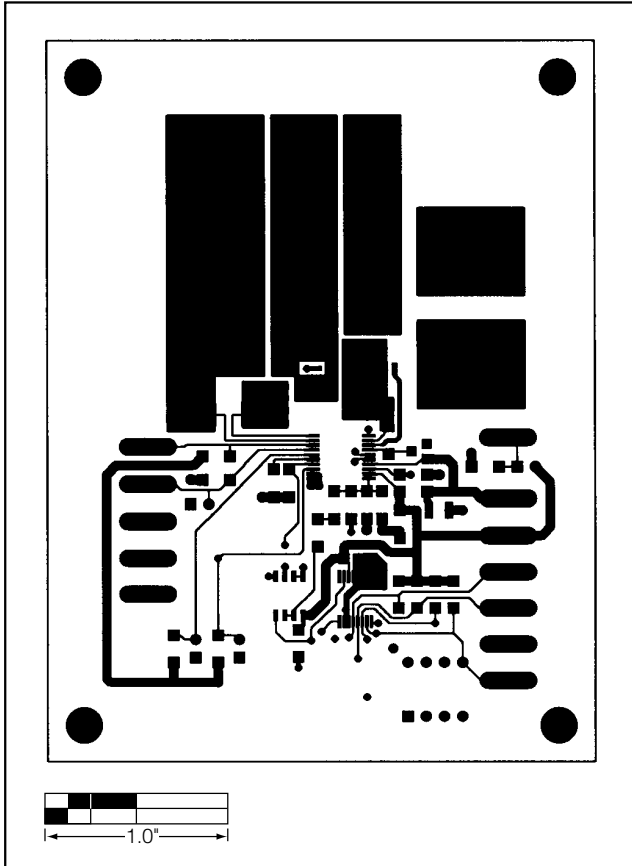

Figure 4. MAX1636 EV Kit PC Board Layout—Component Side

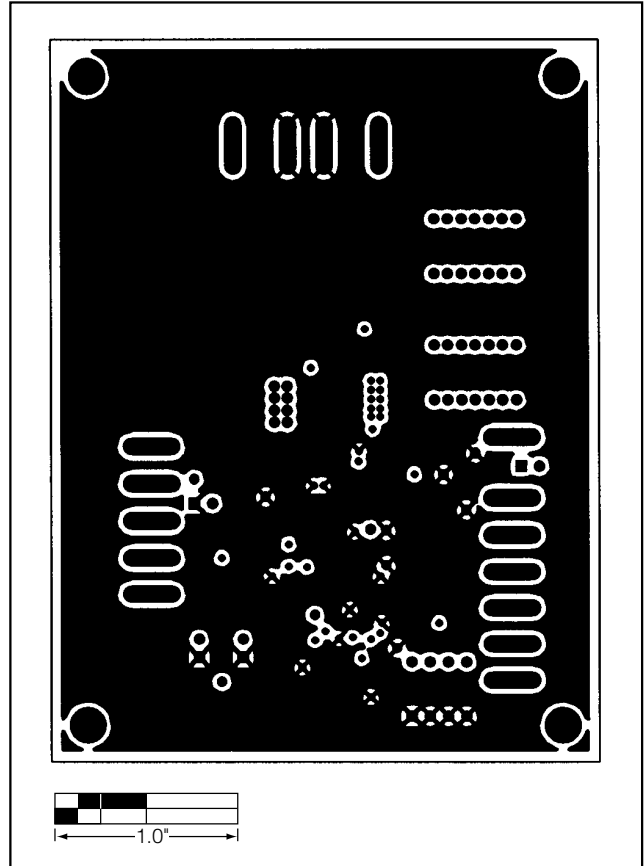

Figure 5. MAX1636 EV Kit PC Board Layout—Two Internal GND Planes

MAX1636 CPU Supply Evaluation Kit

Evaluates: MAX1636

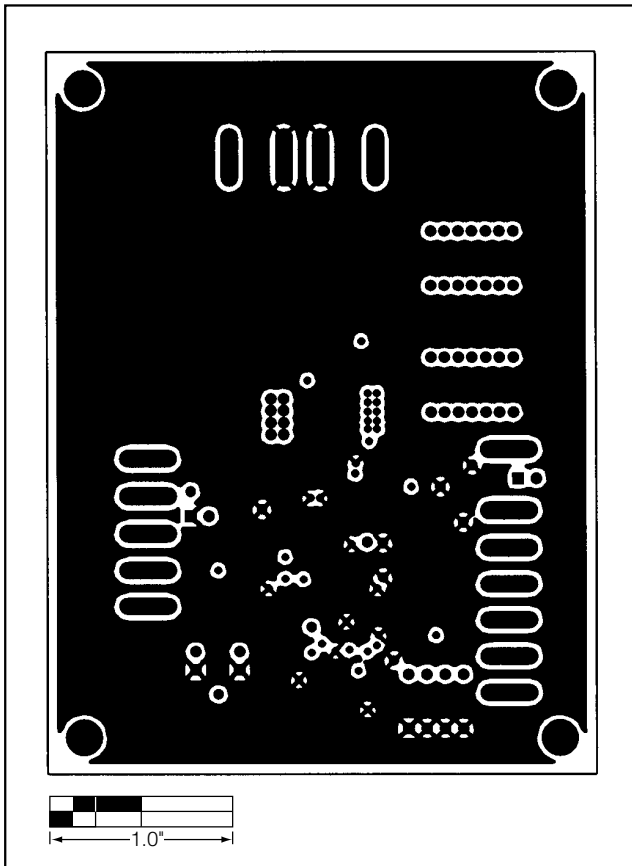

Figure 6. MAX1636 EV Kit PC Board Layout—Three Internal GND Planes

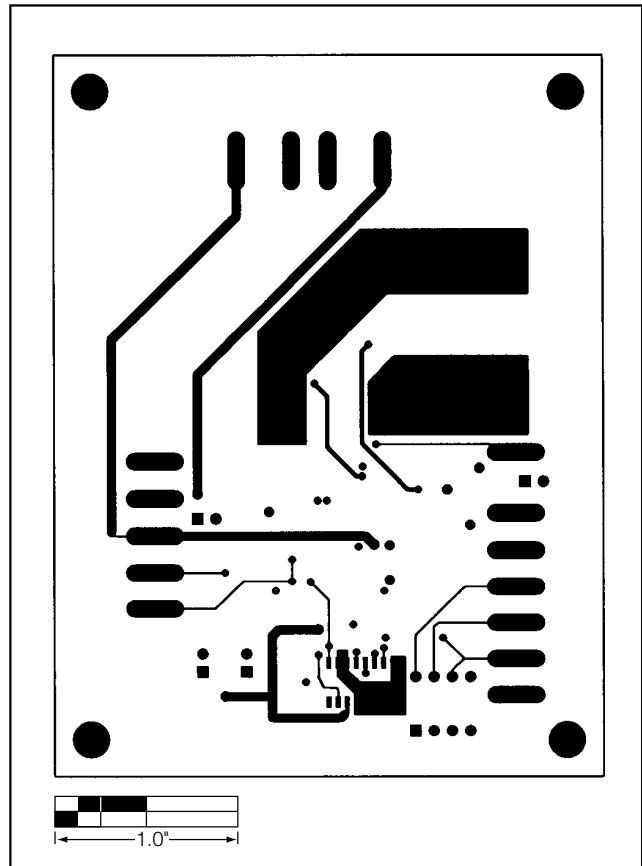

Figure 7. MAX1636 EV Kit PC Board Layout—Solder Side

Maxim cannot assume responsibility for use of any circuitry other than circuitry entirely embodied in a Maxim product. No circuit patent licenses are implied. Maxim reserves the right to change the circuitry and specifications without notice at any time.

Maxim Integrated Products, 120 San Gabriel Drive, Sunnyvale, CA 94086 408-737-7600 _____ 7